



SECURE-TECH

DETENTION ELECTRONIC SYSTEMS
ETECH CONTROLS CORPORATION - MANUFACTURER
4051 ALVIS COURT #3, ROCKLIN, CALIFORNIA, USA 95677
TEL (916) 630-1300 • FAX (916) 630-1100 • FREE (800) 800-2523

**MODEL
HC-0811**

8 DOOR INTERLOCK CONTROLLER

FEATURES:

- 8 INTERLOCK INPUTS
- 8 INTERLOCK OUTPUTS
- 8 INTERLOCK OVERRIDES
- INTERLOCKED CONTROL SWITCHES
- ANY INTERLOCK SIZE
- MULTIPLE INTERLOCK GROUPS
- ALL PLUG CONNECTION
- 3.25" SNAP TRACK MOUNT
- 2 YEAR WARRANTY

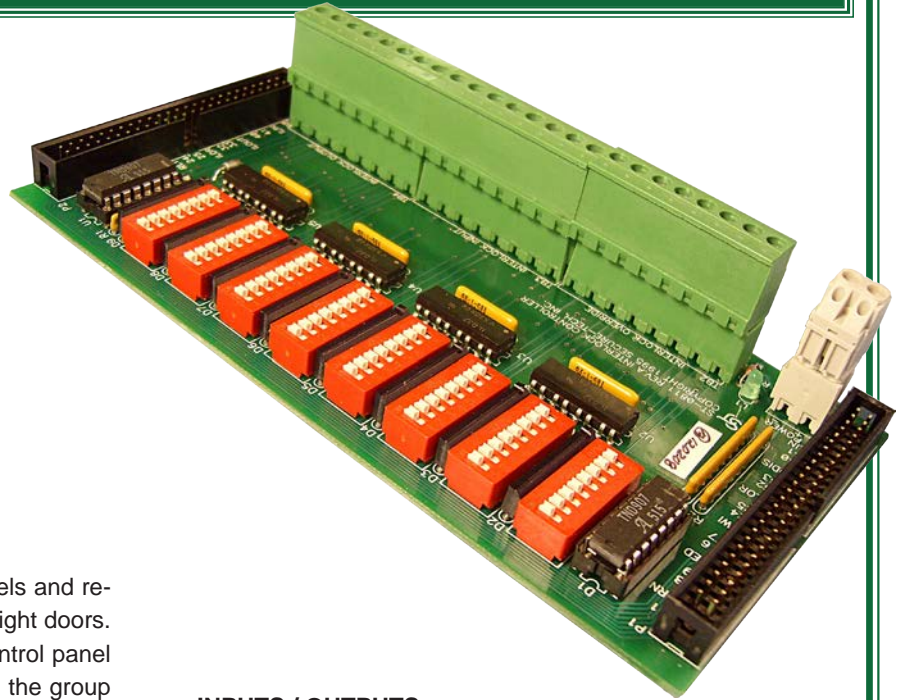

FUNCTIONAL DESCRIPTION:

The HC-0811 interfaces between control panels and relay output boards to provide interlocking for eight doors. Interlocking a group of doors prevents the control panel operator from opening more than one door in the group at a time. An Override input is provided for each door to allow interlocked doors to be opened in case of fire or other emergency.

Control switch inputs are also interlocked to prevent the simultaneous activation of multiple control switches from using the time delay encountered in receiving a changed door status condition in an attempt to defeat the interlock. Only one switch input in an interlock group is recognized at a time.

The doors in an interlock group can be spread over multiple Interlock Controllers. This allows any number of doors to be in a single interlock group and any number of groups to be interlocked with other groups. This also allows all eight door interlock circuits to be utilized.

Each controlled door circuit is dip switch selected to interlock with other doors controlled by this board and with interlock group inputs from additional controller boards.

INPUTS / OUTPUTS:

The Override, Group, and power inputs; and Group outputs are connected to Phoenix type compression screw terminal plugs sized for 22 to 12 AWG stranded conductors. Two 50-pin male headers are provided for door status I/O; door switch, Override, and Group inputs; Group and door relay outputs connection, via ribbon cable, to control panels (convert to 25 pair cable) and other boards. The mating female ribbon plugs are provided.

SIZE:

3.25" W x 6.50" L x 1.25" D
82.6mm W x 165.1mm L x 31.7mm D

POWER:

12 - 14 VDC, 200ma, green LED indicated

MODEL

HC-0811 8 DOOR INTERLOCK CONTROLLER

HOOK-UP DIAGRAM

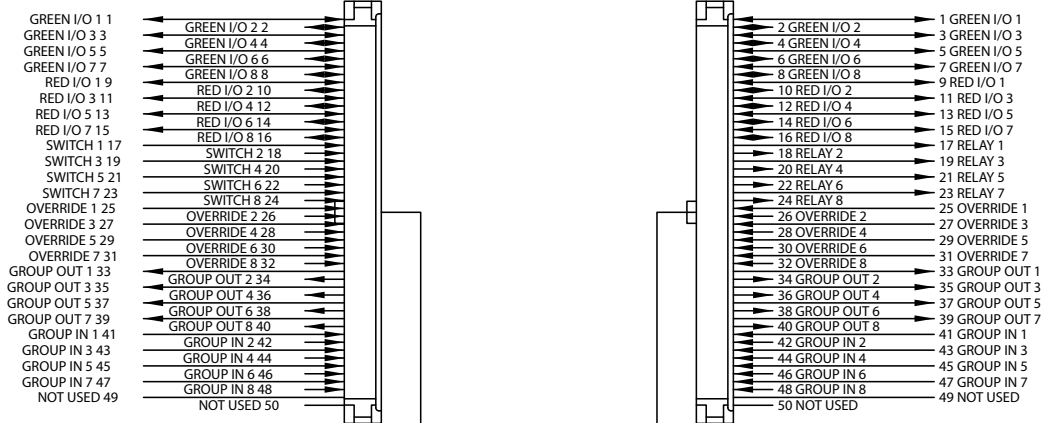

SET TO SELECT OTHER DOORS ON THIS CONTROLLER TO INTERLOCK WITH

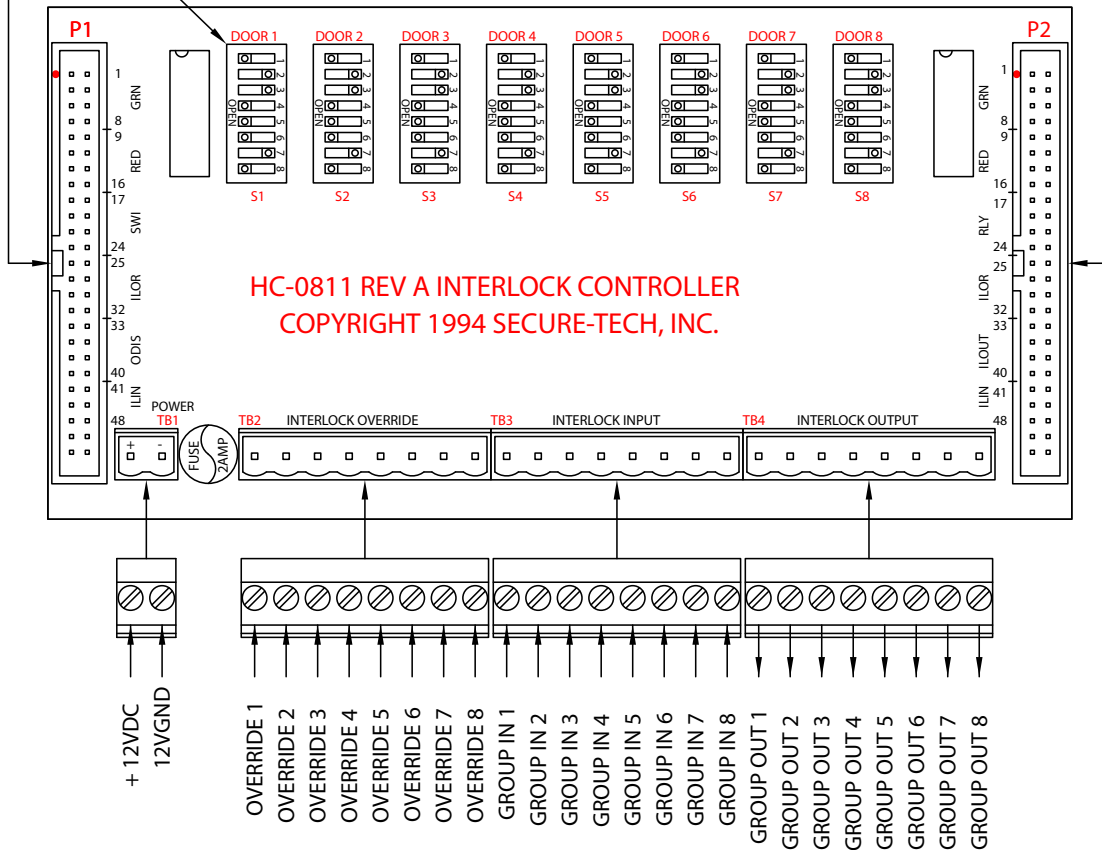

NOTE: INTERLOCK GROUP OUTPUTS ON P1 & P2 ARE EFFECTED BY OVERRIDES. THOSE ON TB4 ARE NOT EFFECTED BY OVERRIDES.

EXAMPLE 1: Basic #HC-0811 Interlock Configuration:

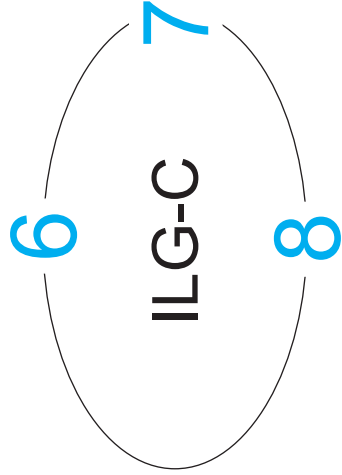
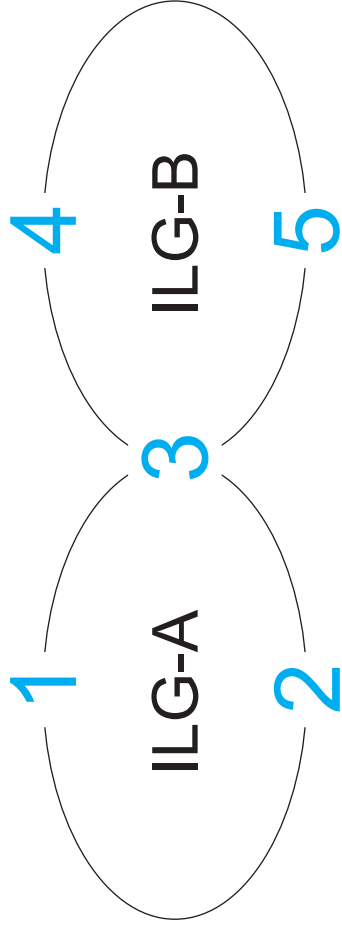

Note:

1. you may assign any individual door to any set of desired Interlock-Groups ("ILG").
2. If more than eight doors form a contiguous, logical Interlock Group, or Groups, you can "cascade" multiple #HC-0811 Interlock Modules (using #TB3 & #TB4) to form larger inter-related interlock groups.
3. Individual "Interlock Override" (ILOR) inputs can be configured to allow flexible groupings (jumper ILOR inputs together), or excluded doors if desired.
 - a. An external relay may be added to create a "Pivot Door" that disables related ILOR Overrides when the "Pivot Door" is un-secure, as is used on CDCR 270-Housing Control-Room Entry Doors.
4. #TB3 External Interlock "RED" Inputs can be used to additionally interlock IHC-0811 doors with doors on other #HC-0811 modules, or to any other "status" input desired (DPS status, Alarms, Day/Night-Relay, etc.).

ILG-A:
Door-1
Door-2
Door-3

ILG-B:
Door-3
Door-4
Door-5

ILG-C:
Door-6
Door-7
Door-8

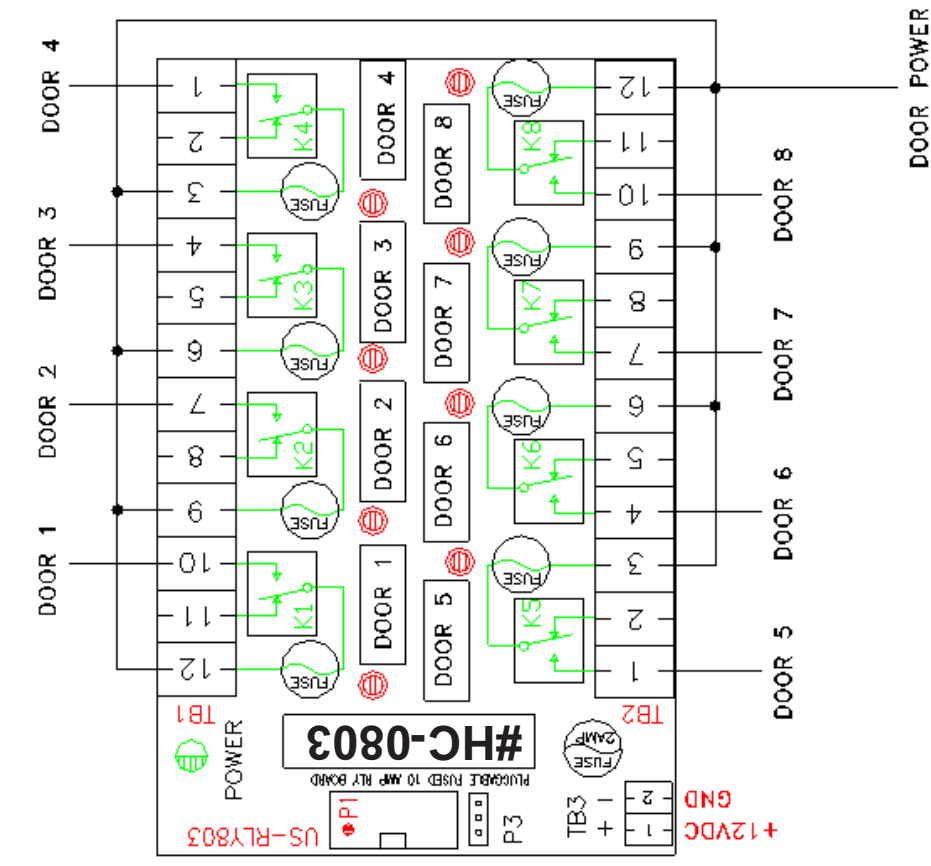
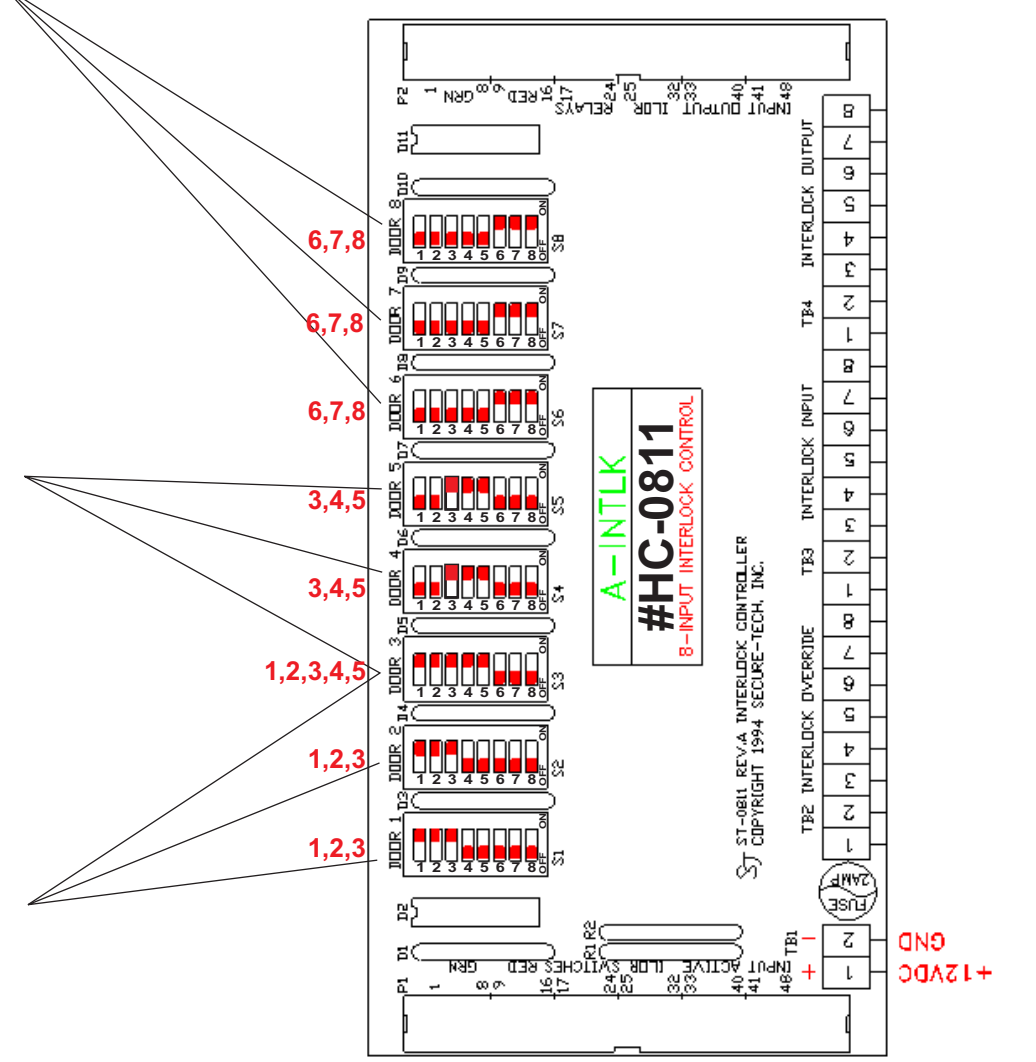

EXAMPLE 2: More Complex, 8-Door #HC-0811 Interlock Configuration:

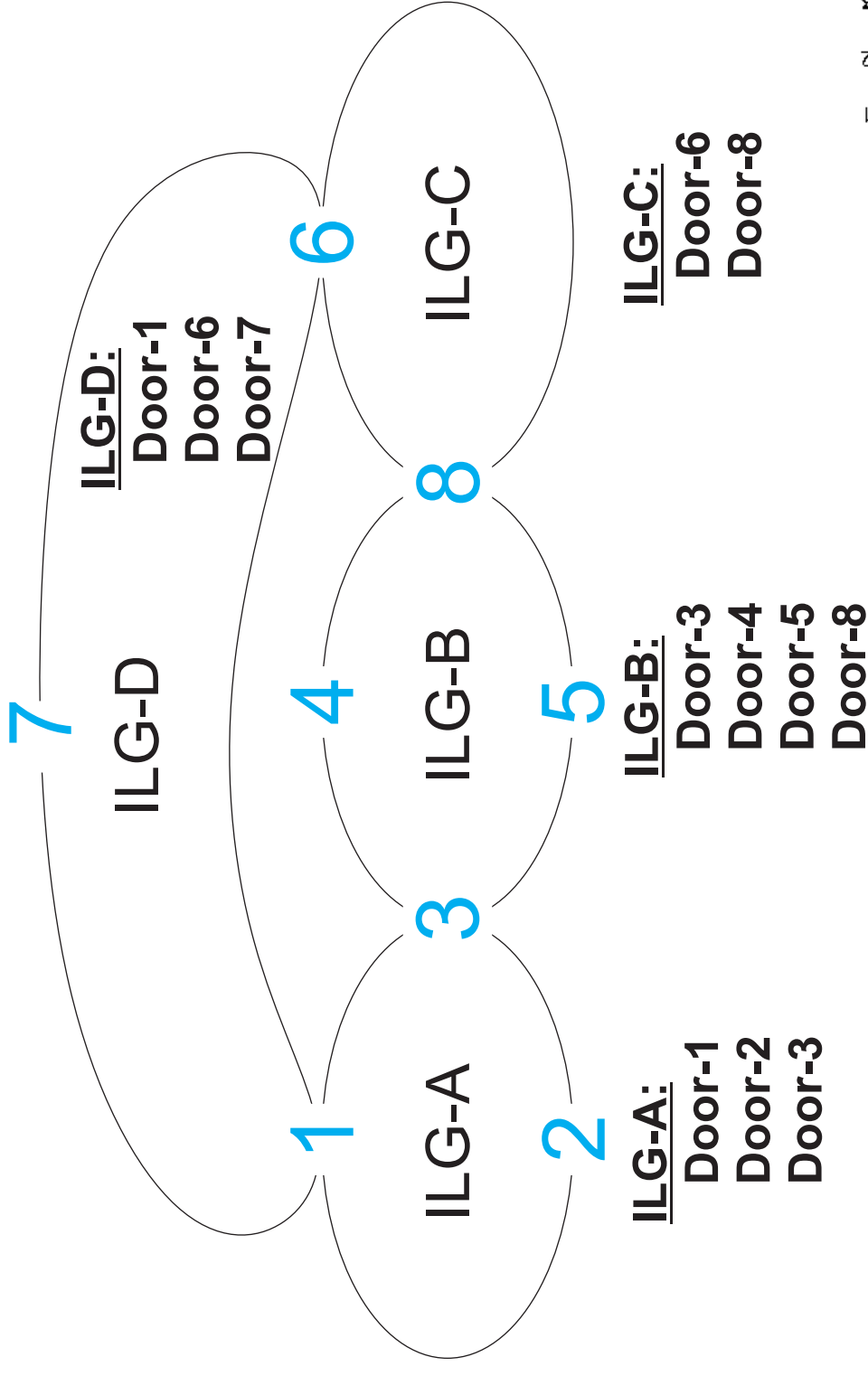

Note:

1. you may assign any individual door to any set of desired Interlock-Groups ("ILG").
2. If more than eight doors form a contiguous, logical Interlock Group, or Groups, you can "cascade" multiple #HC-0811 Interlock Modules (using #TB3 & #TB4) to form larger inter-related interlock groups.
3. Individual "Interlock Override" (ILOR) inputs can be configured to allow flexible groupings (jumper ILOR inputs together), or excluded doors if desired.
 - a. An external relay may be added to create a "Pivot Door" that disables related ILOR Overrides when the "Pivot Door" is un-secure, as is used on CDCR 270-Housing Control-Room Entry Doors.
4. #TB3 External Interlock "RED" Inputs can be used to additionally interlock doors with doors on other #HC-0811 modules, or to any other "status" input desired (DPS status, Alarms, Day/Night-Relay, etc.).

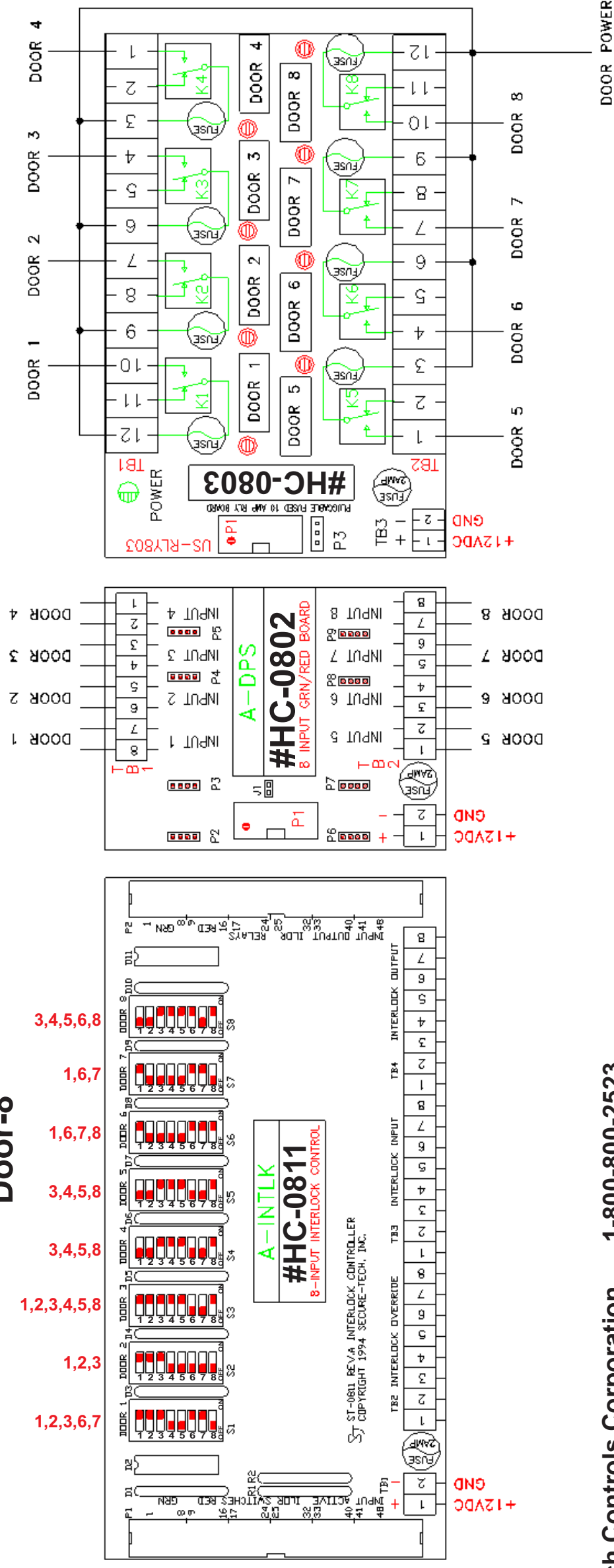

FACEPANEL COMPONENTS

CONTROL ELECTRONICS PANEL END-OF-LINE EQUIPMENT

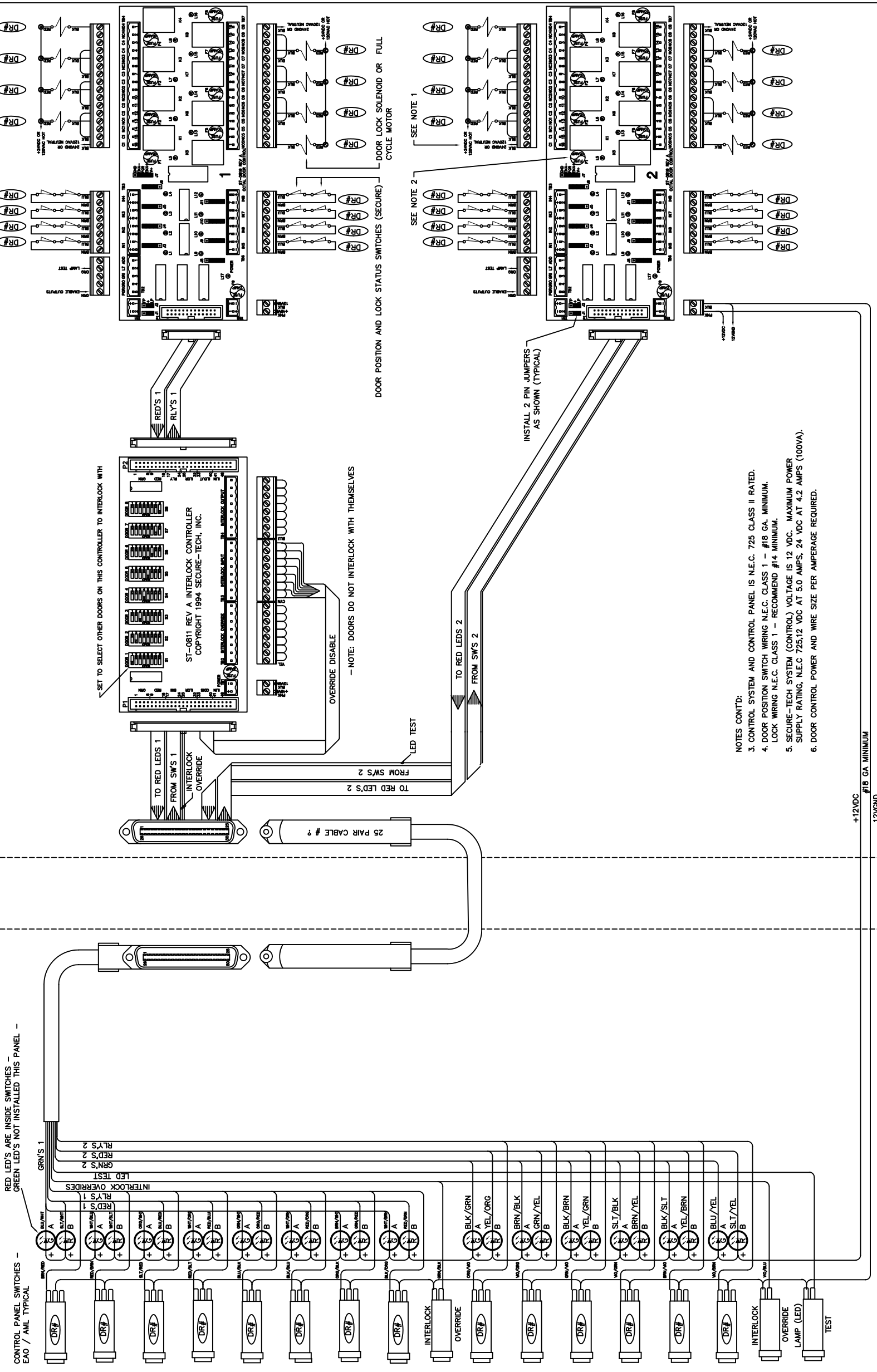

CONTROL PANEL SWITCHES - EAO / AML TYPICAL

RED LED'S ARE INSIDE SWITCHES - GREEN LED'S NOT INSTALLED THIS PANEL -

SET TO SELECT OTHER DOORS ON THIS CONTROLLER TO INTERLOCK WITH

ST-0811 REV A INTERLOCK CONTROLLER
COPYRIGHT 1994 SECURE-TECH, INC.

NOTE: DOORS DO NOT INTERLOCK WITH THEMSELVES

DOOR POSITION AND LOCK STATUS SWITCHES (SECURE) CYCLE LOCK SOLENOID OR FULL CYCLE MOTOR

SEE NOTE 1

SEE NOTE 2

INSTALL 2 PIN JUMPERS AS SHOWN (TYPICAL)

- NOTES CONT'D:
- CONTROL SYSTEM AND CONTROL PANEL IS N.E.C. 725 CLASS II RATED.
 - DOOR POSITION SWITCH WIRING N.E.C. CLASS 1 - #18 GA. MINIMUM.
 - LOCK WIRING N.E.C. CLASS 1 - RECOMMEND #14 MINIMUM.
 - SECURE-TECH SYSTEM (CONTROL) VOLTAGE IS 12 VDC. MAXIMUM POWER SUPPLY RATING, N.E.C 725.12 VDC AT 5.0 AMPS, 24 VDC AT 4.2 AMPS (100VA).
 - DOOR CONTROL POWER AND WIRE SIZE PER AMPERAGE REQUIRED.

+12VDC #18 GA MINIMUM
12V/GND

- NOTES:
- SELECT DOOR LOCK OPERATING VOLTAGE: 24VDC OR 120VAC. ERASE THE ONE NOT USED. WIRE COLORS, RED AND BLACK, ARE BASED ON 24VDC. CHANGE BLACK TO WHITE AND RED TO BLACK FOR 120VAC.
 - FUSES MUST BE SIZED FOR THE PROPER RELAY CIRCUIT VOLTAGE RATING: 10 AMP=250VAC, 6 AMP=277VAC OR 5 AMP=30VDC. EXPLODE THE 0819A PCB BLOCK AND EDIT THE PLUGFUSE BLOCK ATTRIBUTE FOR EACH RELAY CIRCUIT.

DOOR CONTROL SYSTEM BASED UPON PRODUCTS MANUFACTURED BY SECURE-TECH, ROCKLIN CA.

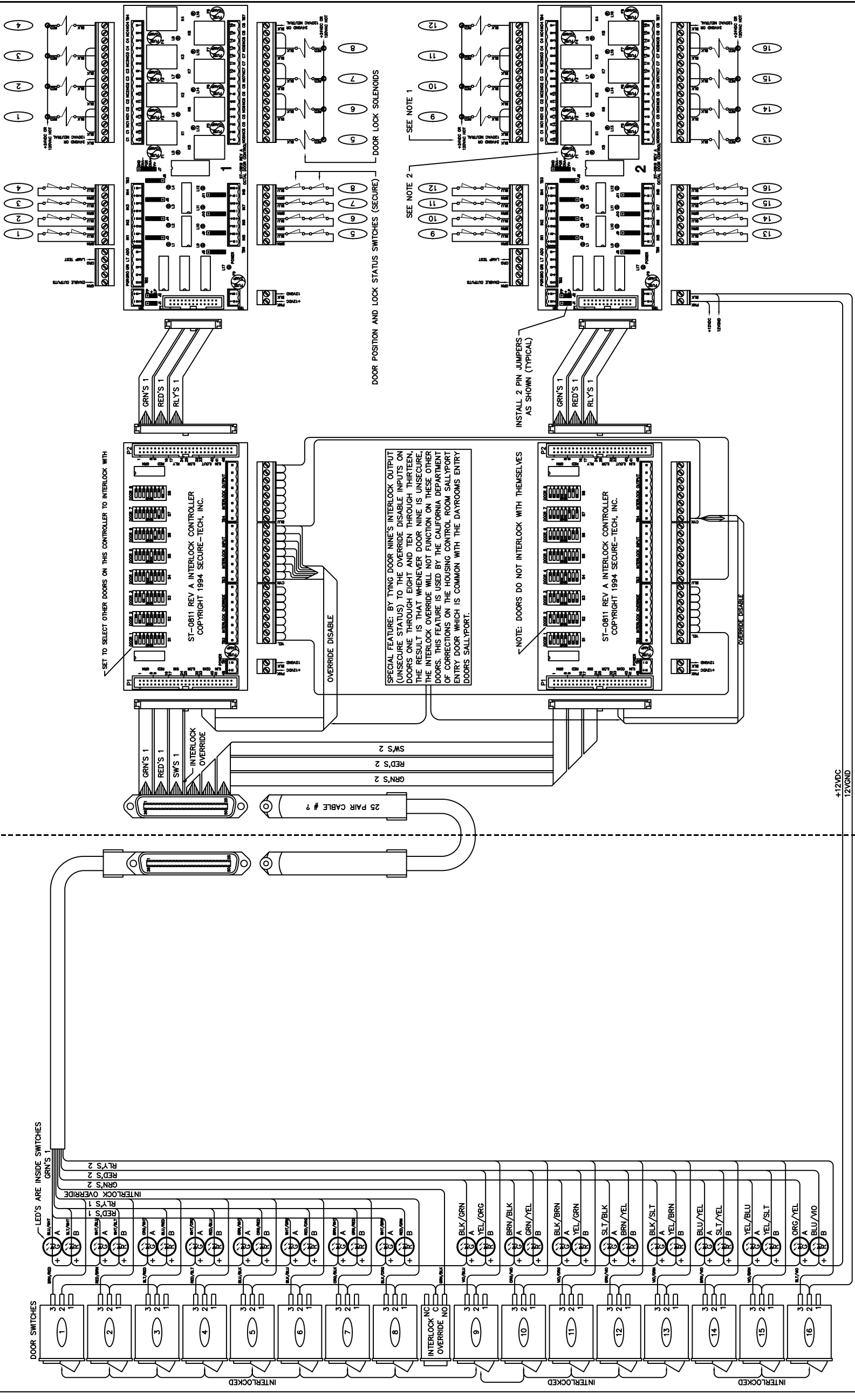

- NOTES:
1. SELECT DOOR LOCK OPERATING VOLTAGE: 24VDC OR 120VAC. ERASE THE ONE NOT USED. WIRE COLORS, RED AND BLACK, ARE BASED ON 24VDC. CHANGE BLACK TO WHITE AND RED TO BLACK FOR 120VAC.
 2. FUSES MUST BE SIZED FOR THE PROPER RELAY CIRCUIT VOLTAGE RATING: 10 AMP=250VAC, 6 AMP=277VAC OR 5 AMP=30VDC. EXPLODE THE 0819A PCB BLOCK AND EDIT THE PLUGFUSE BLOCK ATTRIBUTE FOR EACH RELAY CIRCUIT.